

Schnellspannsysteme

Quick-action clamping systems

Systèmes de serrage rapide

2

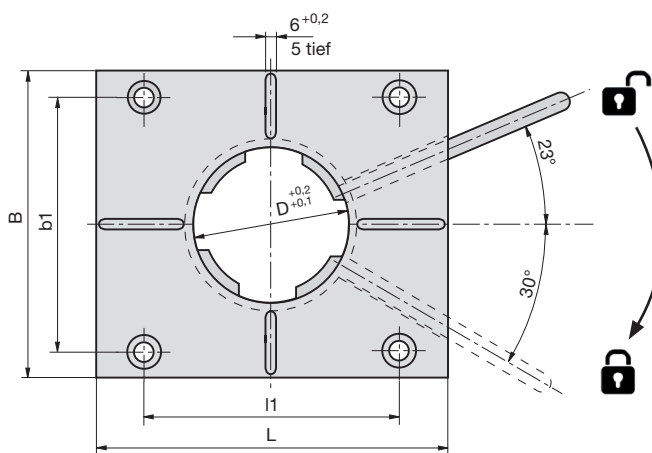
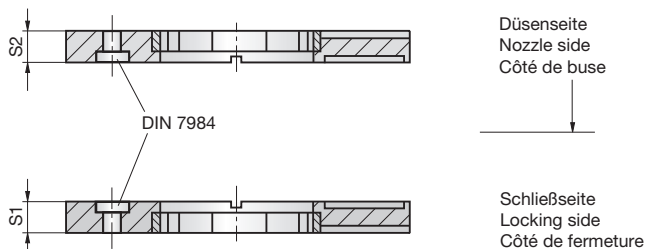
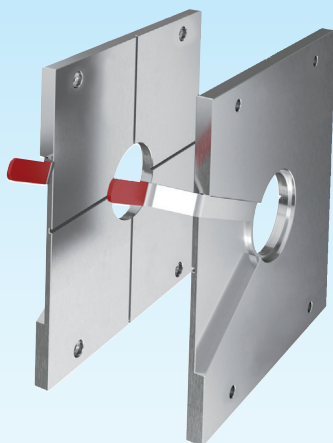

Z8060-

Mat.: ST

Z8060-Type



Type	B	L	b1	l1	D	S1	S2
10	218	246	181,8	105	100	17	17
20	218	246	210	105	110	17	17
30	246	218	210	70	100	17	17
40	246	218	190	70	110	17	17
50	246	218	210	120	110	17	17
60	246	246	210	210	110	17	17
70	246	246	210	210	125	17	17
80	296	296	210	210	110	17	17
90	296	296	210	210	125	17	17
100	296	296	210	210	125	17	17

Wärmeisolerplatte
Z7923 optional
Thermal insulating
plate Z7923 optional
Plaque isolante Z7923
optionale

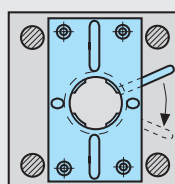
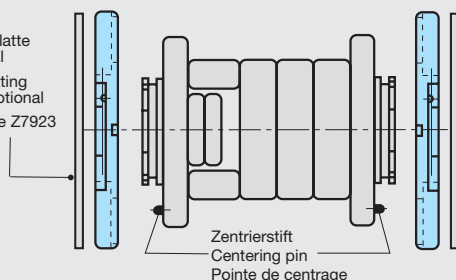

Einbau 1
Mounting 1
Montage 1

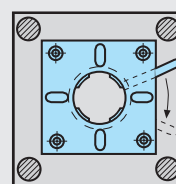

Einbau 2
Mounting 2
Montage 2

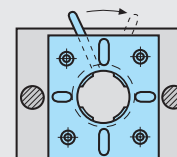

Einbau 3
Mounting 3
Montage 3