User Guideline

Temperature control unit TCU-90L



General information

This documentation is copyrighted. Unauthorized duplication is prohibited by law. To the best of our knowledge and belief, the information contained in this documentation is true and correct as of the date of publication. The contents, however, do not constitute a binding obligation on the part of MOULDPRO APS and are subject to change without notice.

© Copyright 2019 MOULDPRO APS

Contents

1 Indhold

2	GENERAL SAFETY INFORMATION	5
2.1	SAFETY SYMBOLS	5
2.2	RANGE OF APPLICATION	5
2.3	INTENDED USE	5
2.4	SAFETY INFORMATION	6
2.4.1	<i>General Information</i>	6
2.4.2	<i>Process Monitoring</i>	6
2.4.3	<i>Information for Operators and Personnel</i>	6
2.4.4	<i>Changing the Parameters</i>	7
2.4.5	<i>Residual risks</i>	7
2.5	USING THIS DOCUMENTATION	8
2.5.1	<i>Additional Documentation</i>	8
3	OVERVIEW TEMPERATURE CONTROL UNIT	9
3.1	FRONT VIEW	9
3.2	REAR VIEW	10
3.3	IDENTIFICATION OF RESIDUAL RISK ON THE UNIT	11
4	TECHNICAL SPECIFICATIONS	12
5	INSTALLATION	13
5.1	INSTALLING AND DIMENSIONS OF THE TEMPERATURE CONTROL UNIT	13
5.2	CONNECTIONS	14
5.3	POWER SUPPLY	15
5.4	INITIAL OPERATION - FILLING	16
5.5	PUMP ROTATION CHECK	16
5.6	DISPLAY OF PUMP PRESSURE	16
6	OPERATIONS	16
6.1	OVERVIEW	17
LEDS PROCESS INFORMATION AND START PUMP		18
7	DISPLAY AND PARAMETER SETTINGS	19
8	ALARM DISPLAY	21
9	STANDARD PCB SETTINGS	22
9.1	ADVANCED PARAMETER SETTINGS	24
10	LEAK MONITORING	30
10.1	DEACTIVATE LEAK MONITORING	31
11	CONFIGURABLE RELAYS	32
12	DESCRIPTION PCB CARD CONNECTORS	34
13	MAINTENANCE	34
13.1	INSPECTION	35
13.2	CLEANING	35

13.3	REPAIR	35
14	OUT-OF-SERVICE / TRANSPORT	36
15	DISPOSAL	36
16	WATER QUALITY	37
17	ELECTRICAL DIAGRAM	38
18	WATER CIRCUIT DIAGRAM	39
19	CONTROL CIRCUIT DIAGRAM	40
19	COMPONENTS AND SPARE PART LIST	41

2 General Safety Information

2.1 Safety Symbols

DANGER	
	Denotes imminent danger. Failure to heed the information can result in death or grave personal injury (disability)!

WARNING	
	Denotes a dangerous situation. Failure to heed the information can result in death or grave personal injury (disability)!

CAUTION	
	Denotes a potentially dangerous situation. Failure to heed the information can result in property damage as well as minor or moderate personal injury!

NOTE	
	Denotes general information, useful advice to users and work recommendations, which, however, do not have any influence on the safety and health of personnel.

2.2 Range of Application

This general safety information is generally valid for all temperature control units from MOULDPRO.

2.3 Intended Use

The MOULDPRO temperature control unit is build according to the current state of the art and the generally accepted principles of safety engineering. The temperature control unit is intended solely for the normal use for heating and/or cooling of injection and die casting moulds, extruders, and mixers in areas in which there is no risk of explosion.

Any use beyond this shall be deemed to constitute improper use. The manufacturer is not responsible for damage resulting from improper use; the user is solely responsible for such risks. The temperature control unit may not be used under other operating conditions and/or with other media, in deviation from our specifications, without the prior consent of MOULDPRO.

Use as intended also entails compliance with the operating, servicing and maintenance conditions stipulated by the manufacturer. The temperature control unit may only be operated, serviced and maintained by personnel who are familiar with these tasks and have been instructed as to the risks.

2.4 Safety Information

2.4.1 General Information

The MOULDPRO temperature control unit is safe to operate, but this device can pose danger to life and limb if it is used incorrectly or for a purpose other than that intended. It should be noted that this poses risks to the life and limb of the user or third parties, adverse effects on the equipment and other material assets belonging to the user, and risks to the efficient operation of the equipment.

Start-up (i.e., commencement of intended use) is prohibited until it has been determined that the temperature control unit has been set up and wired in accordance with the Machinery Directive (2006/42/EC). EN 60204-1 (Safety of Machinery) must also be observed.

These operating instructions must be read carefully before turning on and operating the temperature control unit. The information regarding the intended use and foreseeable misuse must be observed. Local safety regulations must also be obeyed.

If the temperature control unit is used in combination with products by other manufacturers, their notices and safety regulations must also be obeyed.

2.4.2 Process Monitoring

In plants in which a temperature control system malfunction leads to endangerment of the operating personnel or destruction of the plant, an independent process monitor that shuts down the plant reliably must be used.

2.4.3 Information for Operators and Personnel

The operator and all persons who are tasked with working on the temperature control unit must obey the fundamental regulations regarding work safety and accident prevention. The operator must ensure that only persons who have read and understood these operating instructions, particularly the chapter on safety, work on the temperature control unit.

WARNING	
	People with pacemaker should not be allowed to demount or maintain the magnetically coupled pump!

Any working methods that have a negative effect on the technical safety of the temperature control unit must not be used. The operator must ensure that the temperature control unit is operated only in flawless condition.

If necessary, the company using the equipment must obligate the operating personnel to wear protective clothing.

For all tasks having to do with set-up, start-up, operating, modification of operating conditions and operational modes, maintenance, inspection and repair, any shutdown procedures stated to be necessary in the operating instructions must be followed.

2.4.4 Changing the Parameters

The parameters of the control system may only be changed by personnel trained by MOULDPRO. No parameters in the device configuration may be changed without consulting MOULDPRO.

The relevant accident prevention regulations and the generally accepted principles of safety engineering, occupational medicine and structural engineering must be observed. The national safety regulations must also be obeyed.

2.4.5 Residual risks

Any unauthorized modifications and changes to the temperature control unit as well as unauthorized changes to the parameters of the control system are prohibited for reasons of safety.

If the temperature control unit is damaged, it must not remain in use; the defective part must be replaced or repaired immediately. Only original MOULDPRO replacement parts may be used. Damage due to use of third party parts voids any and all warranty claims.

DANGER	
	The temperature control unit must be rendered currentless before it is opened! Press the main switch on the temperature control unit and unplug mains plug! Danger due to electrical shock!

Repair leaks in the temperature control circuit (device, connecting lines, etc.) immediately.

In temperature control units that use oil as a heat transfer medium, it should be noted that oil is flammable under certain conditions. For this reason, the temperature control unit must not be located in the vicinity of heat sources. The thermal insulation in the device must always be kept clean. Insulation that is soaked with thermal oil poses an increased risk of fire.

Burning thermal oil can be extinguished using a spray foam fire extinguisher, a powder fire extinguisher (avoid with dust-sensitive plants, control systems, EDP, etc.) or a CO₂ fire extinguisher. The appropriate fire extinguisher must be provided by the operator, taking into account the equipment located in the room and the mandatory safety regulations.

The temperature control unit may only be operated when all safety systems are completely installed and intact. The temperature control unit must be protected against sprays and cleaning agents.

Before detaching connecting lines in the temperature control circuit and depending on the outlet temperature, allow the temperature control unit to cool down first and then turn it off. Check that the pump is no longer running.

WARNING	
	Important - danger of injury in the event of escaping water or oil!

2.5 Using this Documentation

This documentation contains important information for safe, economical operation and for proper maintenance of the device.

Compliance with this documentation helps to avoid danger, minimize repair costs and downtime, and increase the dependability and service life of the unit/system.

NOTE	
	The operating instructions should be kept near the corresponding unit and always be accessible to operating and maintenance personnel.

2.5.1 Additional Documentation

The included documentation is completely correct for the basic versions of units. Components that do not belong to the basic hardware are noted as extra equipment. The corresponding additional documents are included with special versions of devices. Any additional documents supplement and/or replace the descriptions contained in this documentation, which are then either invalid or only conditionally valid.

3 Overview temperature control unit

3.1 Front view



1	Temperature Controller
2	Pump ON/OFF (TCU-90 and TCU-90L pump direction)
3	Main switch
4	Cover- Electric section
5	Cover- Hydraulic section

3.2 Rear view

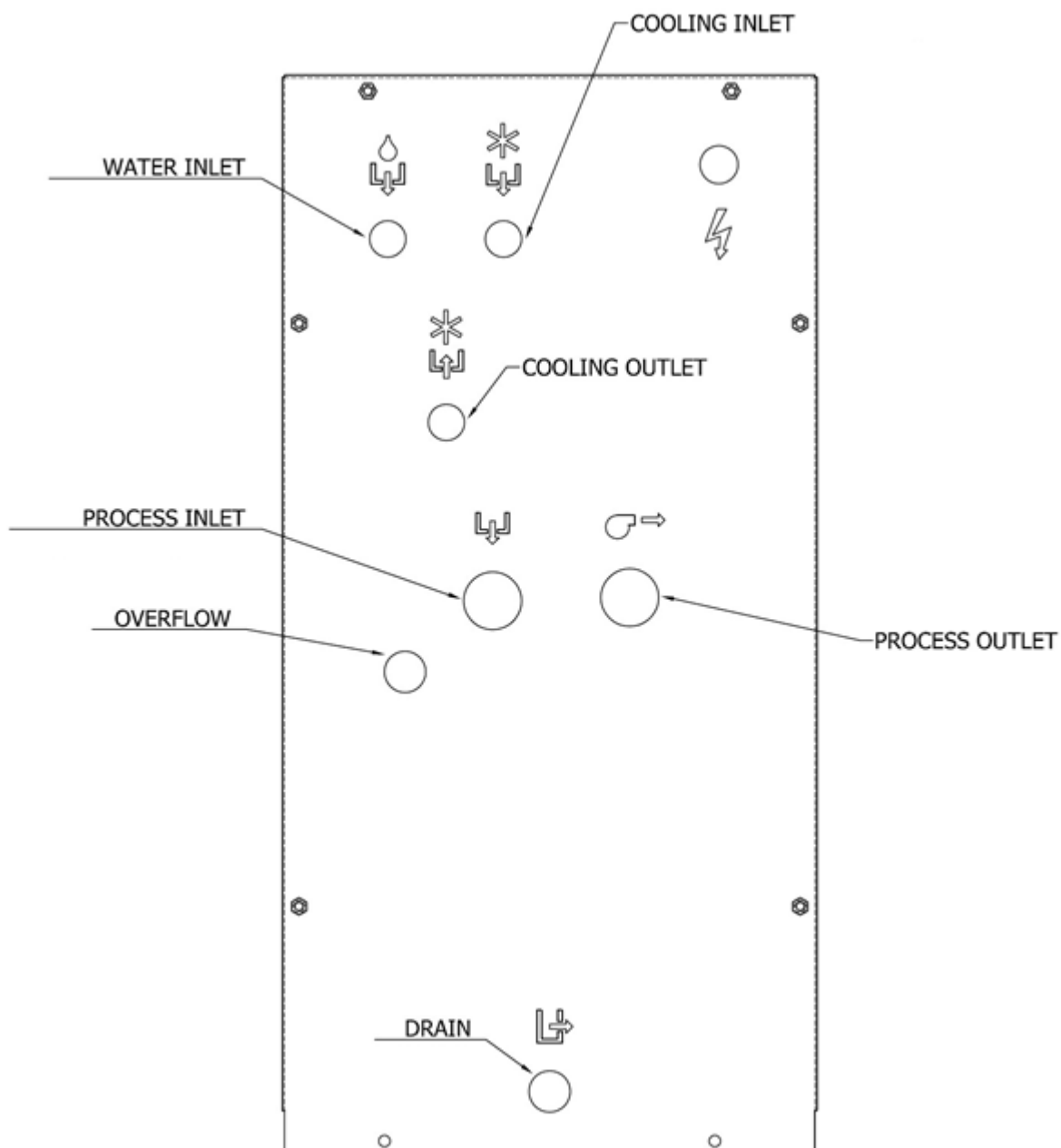

3.3 Identification of residual risk on the unit

On the temperature control unit following pictograms are mounted to identify the residual risk.



DANGER	
	<p>The temperature control unit must be rendered current less before it is opened! Turn off the main switch on the temperature control unit and disconnect the power cord from the wall socket! Danger due to electrical shock!</p>

4 Technical Specifications

Temperature range	up to 90°C with water
Temperature control	self-optimizing, electronic microprocessor controller
Heating capacity	Water operation: 18 kW,
Pump capacity	motor 0,50 kW Pressure mode: max. 3,5 bar / max. 60 l/min Vacuum mode: vacuum max. 8mH ₂ O
Cooling capacity	approx. 40 kW at 90°C
Filling amount	approx. 35 liters
Connections	to mould 3/4" BSP female thread
	from mould 3/4" BSP female thread
	cooling water inlet with water filter 3/4" BSP female thread
	cooling water outlet 1/2" BSP male thread
Dimensions (LxWxH)	750 x 365 x 785 mm
Weight	approx. 60 kg empty
Category of protection	IP-44
Electric	In separate switch cabinet, easily accessible from the front

5 Installation

Before starting the unit, the electrical and hydraulic connections have to be installed. The installation of the unit has to be done in the order of the following chapters. After the proper installation, the unit is ready to use.

DANGER	
	<p>The temperature control unit must only be operated with water. Do not use solvents or other explosive substances such as petrol, toluene, etc. in the water.</p>

CAUTION	
	<p>When starting the unit without the prescribed connections the unit can be damaged. Water quality – do not use water with chlorine addition.</p>

NOTE	
	<p>Observe the General Safety Information! Before installing corresponding chapter of the manual should be read!</p>

5.1 Installing and dimensions of the temperature control unit

The temperature control unit is designed for an ambient temperature of +10 up to 40°C. Sufficient ventilation must be ensured during set-up. The distance between the temperature control unit and other facilities must be at least 10cm. The ventilation opening must be free.

- Check the unit of completeness and possible damages.
- The unit has to be installed in a suitable location on even ground. It must be stand up right on the wheels (castors).
- The unit is not protected against splash water and is not suitable for use in hazardous location. The unit must not be used in the open air.
- The unit must not be transported lying down, transport in any other position than up right, will damage the unit.

WARNING	
	<p>The temperature control unit can release excess pressure. Danger of injury in the event of escaping steam!</p> <p>Never start up the unit without the protection cover! Never use the unit in hazardous location!</p> <p>Repair leaks immediately! Observe local laws during set-up!</p>

CAUTION	
	<p>The temperature control unit may be pressurized!</p> <p>Only when the pressure gauge shows 0 bar, disconnect hoses!</p>

5.2 Connections

Before installing, the connecting lines between temperature control unit and consumer must be subjected following inspections:

Verify that channels on the consumers are unobstructed

Remove fouling, e.g. remove shaving in the lines

Rust and lime deposits must be removed because they greatly interfere with the heat exchange between consumer and heat transfer medium and increase the pressure drop in the consumer.

For the connecting lines (to and from mould, cooling water inlet and outlet, etc.) the following internal diameters of hoses are recommended:

Thread on the unit	Internal hose-Ø
3/8"	10 mm
1/2"	15 mm
3/4"	20 mm
1"	25 mm
DN32	32 mm

Quick release couplings will give reduced flow. If the recommended tube size cannot be connected to the mould, the connection at the mould should be reduced and not the connection on the temperature control unit. In that way pressure, drops can be avoided.

For the cooling water connections it's enough to use pressure- and temperature-resistant rubber hoses. The tap water pressure has to be between 2,0 and 5,0 bar. We recommend to conduct the water from the unit (cooling water outlet) to an unpressurized outlet.

WARNING	
	<p>To ensure the operational safety is essential to use pressure- and temperature-resistant hoses. Pressure-resistant up to 20 bar / temperature-resistant up to +200°C. For reason of safety, the cooling must always be connected!</p>

NOTE	
	<p>Process water filter on the return line reduces contamination in the unit, which can cause a unit failure (pollution of the solenoid valve). Mark and take down the maximum temperature for which the connections are suitable!</p>

5.3 Power supply

Compare supply voltage and frequency with the information on the serial plate. Verify the rating of the preliminary fuse according to the information in the electrical diagram. Observe local laws during set-up!

Power cable:

Phases	black / brown	L1 / L2 / L3
Earth	yellow/green	PE

WARNING	
	<p>The unit may only be connected by a competent electrician. Ensure easy access to means for cutting the power supply (mains adapter or mains connection), the access must be positioned in a distance of 0.6 and 1.9m above the access level. Do not connect the power supply until the heating medium hoses are connected!</p>

5.4 Initial operation - Filling

The temperature control unit has to be connected hydraulically and electrically. Possible block valve must be open.

Switch on the unit electrically: Turn on the main switch and press the unit ON/OFF-switch

After switching on the unit the pump starts and fills the system with water, as well as automatically ventilating the machine. In the meantime the yellow lamp lights and the horn sounds. The unit can stop and start until the system is completely filled. If only the yellow lamp is lit, the unit is running and no horn sounds, the automatic refilling is running.

5.5 Pump rotation check

At the rear side of the unit the direction of rotation can be checked. The unit has been connected to the main supply, hoses must be mounted and heat transfer medium has been filled. Identify the sense of rotation of the motor by switching it on shortly. The sense of rotation must be clockwise as shown by the arrow.

If the sense of rotation is anti-clockwise invert two phases on the electrical connection. This has to be done by a qualified electrician.

5.6 Display of pump pressure

The pump pressure is shown on the manometer.

WARNING	
	<p>The temperature control unit may be pressurised! Only when the pressure gauge shows 0 bar, disconnect hoses!</p>

6 Operations

The temperature controller controls the unit

The temperature controller is a universal controller for all MOULDPRO units.

6.1 Overview

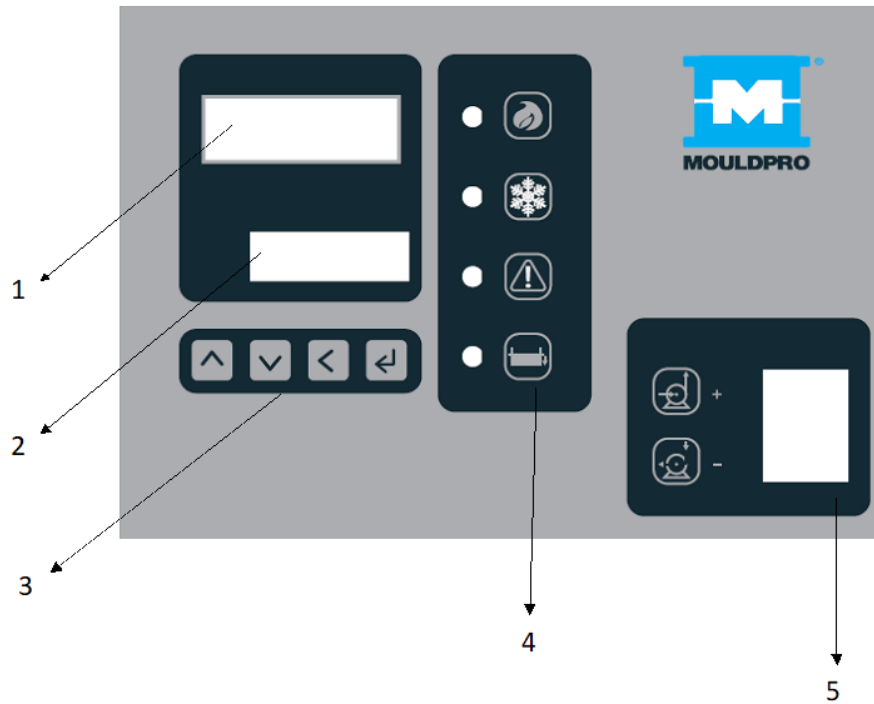

1	Display of set value
2	Display of actual value
3	Function keys
4	Led Keys
5	Pump –On/Off / Pump direction (on TCU- 90 and TCU- 90L)

LEDs process information and start pump.

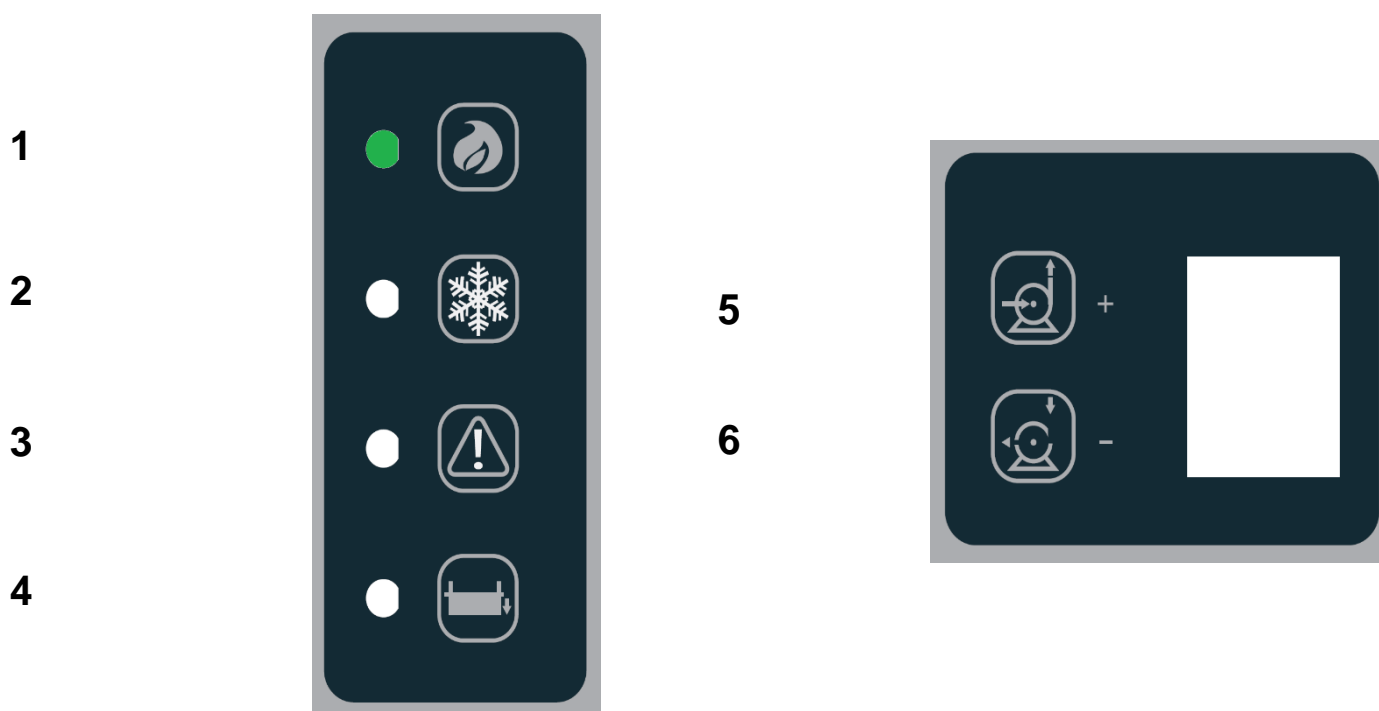

1. Heating led
2. Cooling led.
3. Overload TCU pump led.
4. Low fluid level led.
5. Pump pressure function.
6. Pump depression function.
7. (5 + 6 Only model TCU-90 and TCU-90L)



7 Display and Parameter settings

Zone A



Zone B



To change set point press . Digit on the right side will flash, to change the value press  or .





In order to change the digit press .

Press  to save changes.

To enter the programming SETS, hold the key  and then hold simultaneously the key .











Then in A zone of the display will show ST-0 : To go to the desired ST press .

Once in the desired ST, press  We visualize the first parameter in the ST.

To change the parameter press , to change the parameter value press the keys  or  to change the digit press .

To save changes press .





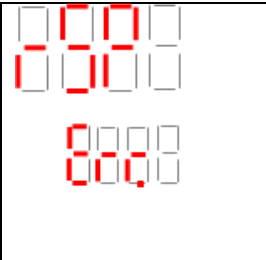
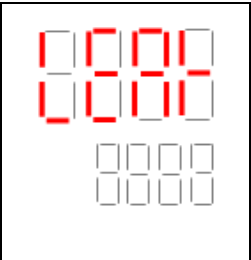
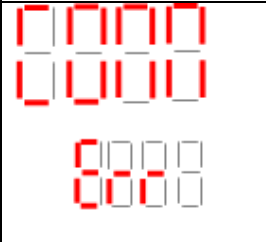
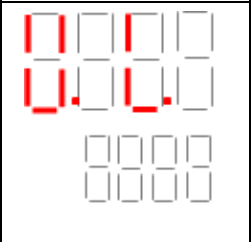

8 Alarm display

Alarm display	Description	Alarm display	Description
	Maximum process start time. User adjustable. Restart TCU unit		Thermocouple error. Disable the heating and pump. Restarts activation leak monitoring
	Minimum return flow alarm. User adjustable. Disables heating.		Overload pump protection. Disable heating and pump. Restarts activation leak monitoring
	Connection between flow meter and PCB card is broken. Disables heating.		Maximum drive pump. User adjustable. Disable heating and pump. Restarts activation leak monitoring
	Connection between process pressure transducer and PCB card is broken.		Maximum temperature difference between process and setpoint. User adjustable
	Connection between return process pressure transducer and PCB card is broken.		Maximum and minimum temperature difference between process and setpoint. User adjustable.



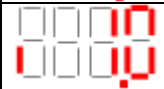

	<p>Connection between Remote set point signal 4...20mA o 0..10Vdc is broken. Holds last Set point value</p>		<p>Possible water leaking problem in the process. Disable heating and pump. Restarts TCU unit.</p>
	<p>No connection between PCB card and RS485 o 0..20mA. Holds last Setpoint value</p>		<p>Low water level for more than 10 seconds continuously in the TCU unit tank. Disable heating and pump. Restarts TCU unit.</p>

9 Standard PCB settings.

Depending on TCU model and activated options, pressing the  key will be shown on the display in B area.

Leak monitoring	
Pressure pump outlet	
Return pressure process	
Process flow in return	
Return temperature	
Return process thermocouple broken	

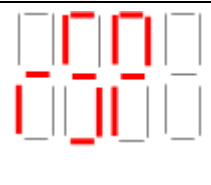
Other messages can be seen in A-B area pressing  if TCU unit has activated configurable relays (R2 or R3).





Configured relays	
Activated relays	
If REMOTE SET POINT function is activated by a signal 4..20mA or external 0..10Vdc, in B area will show in cycles of 3 seconds	
If TCU unit is working through RS485 or 0..20mA communications in B area will show in cycles of 3 seconds	
If we had more machines linked, second TCU unit will show in cycles of 3 seconds	

9.1 Advanced Parameter settings



Each unit requires a different program setting. For each model is a program defined that not every parameter must be set manually. In this program, the model specific settings are saved.

Depending on the type of PCB card, and incorporated options into the TCU unit, there are parameters that are not activated

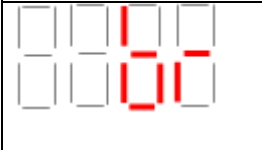

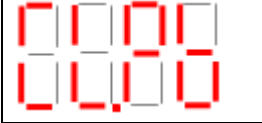

ST-0

	Proportional band of the PID control. Self-adjusting.
	Integral time of PID control. Self-adjusting.
	Derivative time process. Self-adjusting.
	Relay type heating. Not modifiable by the user. SSR- Enables heating through solid state relays. Cont- Activates the heating through the contactor KM3.
	Heating ramp. Do not change without consulting the manufacturer. This parameter is activated when entering the PID control. In cycles 10 seconds, if the temperature has not exceeded this value in degrees, will activate again heating. If on the contrary it has exceeded, heating is not activated until the next cycle, which will return him to look.
	Heating Brake. Do not change without consulting the manufacturer. Heating gives 100% less the value of "br". When it comes down to this value, start the PID control. In pressurized water machines when set point is more than 105 °, PID control began at 95 °.





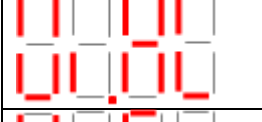



ST-1

	<p>Cooling proportional value. Self-adjusting. Do not change without consulting the manufacturer. It is no unit of measure (proportional value that multiplies the time the cooling solenoid valve is connected. This time is given by the PID).</p>
	<p>Cooling Brake. Do not change without consulting the manufacturer. Cooling gives 100% to the working temperature plus "CL.br" value. When it comes down to this value, start the PID control.</p>
	<p>Cooling ramp. Do not change without consulting the manufacturer. This parameter is activated when entering the PID control. In cycles of 8 seconds, if the temperature has not exceeded this value, it will activate again cooling. If on the contrary it has exceeded, cooling is not activated until the next cycle, which will return him to look.</p>





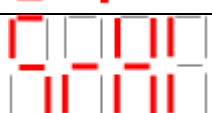



ST-2

	<p>Type of thermocouple. Do not change without consulting the manufacturer. We choose if the thermocouple is J type (TC 1) or Pt1000 (Pt1).</p>
	<p>Flow meter activation. Activate or not the flowmeter. On-OFF.</p>
	<p>Flowmeter signal. Do not change without consulting the manufacturer. Flow meter signal is done by 4...20mA (SrC.A) or 0..10Vdc (SrC.u).</p>
	<p>Activation return sensor. Activate or not in the display the return / external thermocouple On-OFF.</p>
	<p>Type of return / external thermocouple We choose if the thermocouple is J type (TC 1) or Pt1000 (Pt1).</p>

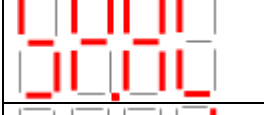
ST-3

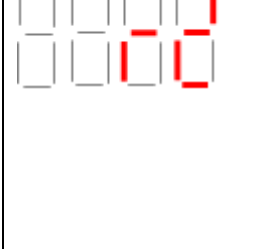
	<p>Temperature type alarm. rEL: relative on the set point. Just above value as "SP.AL" parameter. GAP: on the set point above and below value as "SP.AL" parameter. Activatable when TCU unit reached the set point.</p>
	<p>Overtemperature alarm. It is the alarm value in degrees will act respect to the set point.</p>
	<p>Alarm relay action. dir: Connector CNM1 activates the signal alarm by NO contact . rEu: Connector CNM1 activates the signal alarm by NC contact.</p>
	<p>Enabling remote set point. Activate or not the remote set point On-OFF.</p>
	<p>Remote set point. Remote set point signal "SrC.A" 4..20mA or "SrC.u" 0..10Vdc</p>
	<p>Full-scale remote set point. It is the value in degrees of the maximum temperature of the remote set point.</p>
	<p>Minimum scale remote set point. It is the value in degrees of the minimum temperature of the remote set point. IMPORTANT: If TCU unit has selected the entry "Sr.SC" as "SrC.u" (input 0..10Vdc) the minimum range may not be the value in degrees 0Vdc.</p>
	<p>Maximum value of remote set point. Maximum value in degrees TCU unit can be set by remote set point.</p>
	<p>Outlet process temperature. Type of Input /Output temperature, is done through mA "out.Â" (4-20 mA) or volts "Out.u" (0-10 Vdc). These values will always be proportional between the values in degrees that have been made to the parameters of St-4 "SP.LL" (4 mA-0 Vdc) and "SP.HL" (20 mA-10 Vdc).</p>

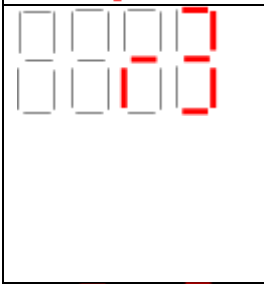
ST-4

	<p>Offset temperature correction. It used to correct the reading of temperature for above and below respect to an external measurement probe.</p>
	<p>Unit temperature. We choose if we want the temperature in degrees Celsius "° C" or degrees Fahrenheit "F".</p>
	<p>Minimum set point setting. It is the minimum temperature machine can be set.</p>
	<p>Maximum set point setting. It is the maximum temperature machine can be set.</p>
	<p>Relay 1 configuration. Not configurable by the user.</p>
	<p>Value in degrees, bars, liters/minute, depending on the configuration of the previous parameter "r1". Not configurable by the user.</p>
	<p>Relay 2 configuration Configurable as: OFF: Disabled tP1: Output temperature to the process. tP2: Return temperature process. P1: Pump pressure. P2: Return process pressure. FM1: Return process flow. AL: General alarm.</p>
	<p>Value in degrees, bars, liters/minute, depending on the configuration of the previous parameter "r2".</p>
	<p>Relay 3 configuration Configurable as: OFF: Disabled tP1: Output temperature to the process. tP2: Return temperature process. P1: Pump pressure. P2: Return process pressure. FM1: Return process flow. AL: General alarm.</p>
	<p>Value in degrees, bars, liters/minute, depending on the configuration of the previous parameter "r3".</p>



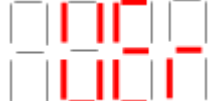

ST-5



	By entering the value 1562, let us enter the St-0 and St-1.
	Software version.

ST-6









	Value to 0, the time to enter the programming SETS is 5 seconds. With value 1, the time to enter the programming SETS is 15 seconds.
---	---



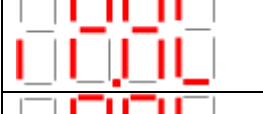

ST-7

	Enabling communications. Activate or communications On-OFF.
	Address assigned to the TCU unit. The first TCU unit will be address 1, if more linked machines the following would be address 2 and so on.
	Transmission speed. "0" (2400bauds), "1" (4800 baud) and "2" (9600 baud).
	Parity bit. "0" (no parity), "1" (non parity) i "2" (even parity).

	<p>Interface type. "420" (4-20mA) or "485" (RS485). When you select "485", the following parameter dEn not appear.</p>
	<p>Data enable. When the interface type is 420 and only have one TCU linked to the MASTER machine, dEn parameter value is "1" (close circuit); if more than one TCU linked all will have dEn value "0" less the last one it will have dEn value "1".</p>

ST-8

	<p>Fluid level setting. Not modifiable by the user. Select if the level control is done by electrode "ELEC" or buoy "BuOY".</p>
	<p>Extra time level detection. Water filling valve retard disconnection time. Value in seconds. NO CHANGE WITHOUT CONSULT THE MANUFACTURER</p>
	<p>Extra time no level detection. Water filling valve retard connection time. Value in seconds. NO CHANGE WITHOUT CONSULT THE MANUFACTURER</p>
	<p>Display activation drive pump. Activate or not the on-off display.</p>
	<p>Alarm output drive pump. Value in bars.</p>
	<p>Initial scale transducer drive pump. Value in bars. NO CHANGE WITHOUT CONSULT THE MANUFACTURER</p>
	<p>Full-scale transducer drive pump. Value in bars. NO CHANGE WITHOUT CONSULT THE MANUFACTURER</p>
	<p>Display Activation return pressure. Activate or not the display. On-off</p>
	<p>Initial scale return transducer drive pump. Value in bars. NO CHANGE WITHOUT CONSULT THE MANUFACTURER</p>

	<p>Full scale return transducer drive pump. Value in bars. NO CHANGE WITHOUT CONSULT THE MANUFACTURER</p>
	<p>Maximum process start time. Value in minutes. NO CHANGE WITHOUT CONSULT THE MANUFACTURER</p>
	<p>Contact NO or NC input level. Not modifiable by the user.</p>
	<p>Leak monitoring. Activate or not the monitoring control. On-OFF.</p>

10 Leak monitoring

Default leak monitoring is enabled, and can be disabled by LM parameter in the St-8 menu.

The process works as follows: Water / oil TCU units:

When process start, letter L (zone B) will flash. When the TCU pump is more than 2 minutes running in continuous, (this will mean that there is no demand for water/oil in the process), the letter L will stop flashing.

From this moment, leak monitoring is enabled. Leak detection:

Once monitoring is enabled (in water process) if we demand for water more than once in an hour, or repetitive demands on for 4 consecutive hours, in zone A message is displayed

LEAK

Will activate the audible alarm by turning off the pump and heating temperature control unit.

Once the user has disconnected the pump switch and confirmed the alarm by pressing



Fix the leakage problem, fixed the leakage connect again the pump switch TCU unit will restart automatically.

Another leak detection (designed for oil TCU units) is:

If the process is more than 10 seconds in oil demand (this may be due to a loss level in the TCU unit) because filling is manual and not incorporating automatic filling in area A the message displayed will be



Will activate the audible alarm by turning off the pump and heating temperature control unit.

Once the user has disconnected the pump switch and confirmed the alarm by pressing



Fix the leakage problem, fixed the leakage connect again the pump switch TCU unit will restart automatically.

10.1 Deactivate Leak monitoring

If the user disables leak monitoring, the letter L (zone B) will not appear.

The alarm will be  disabled.

Alarm  can act, whether the process is water or oil but, pump must be running in continues for 2 minutes.

11 Configurable relays

Depending on TCU model, can add up to 2 configurable relays for user process automation. Making the TCU unit in a process control system.

These switched relays with potential free contacts (support up to 6A), listed as **r2** and **r3** in the St-4 menu, can be configured to work with the control signals incorporating the TCU unit (which are activated by exceeding the value programmed), are:

Pump pressure.

Return pressure.

Outlet process temperature.

Inlet process temperature.

Flow lit/min in return process.

General alarm.

Examples:

The user needs to know when the mold temperature has reached the value he wants to start the process.

Through external thermocouple located in the mold provided by the user to the TCU unit, will control the temperature using the r3 relay.

When the temperature exceeds the set value, the relay r3 provide the user a signal it allow to start the application.

If the mold have no thermocouple could be done as follows:

We will control the temperature of the return process by

the thermocouple at the temperature control unit with relay r3.

Check externally (contact thermocouple, laser gun) when the mold is at optimum operating temperature, and display on the screen which is the return temperature at that time. In this way we could set the value in the relay r3, which will provide the user for future occasions, the signal to start its application in this mold.



Prevent overpressure in inlet mold.

This application could be interesting when our mold has parts that cannot withstand high pressures and need early detection to prevent possible damage.

We will control the pump discharge pressure to the entrance of the user process by r2 with a value (example 3 bar). If this pressure is higher than the preset in r2, this will provide signal to the user, which could perform a bypass between inlet and outlet of the mold and an alarm.

12 Description PCB card connectors

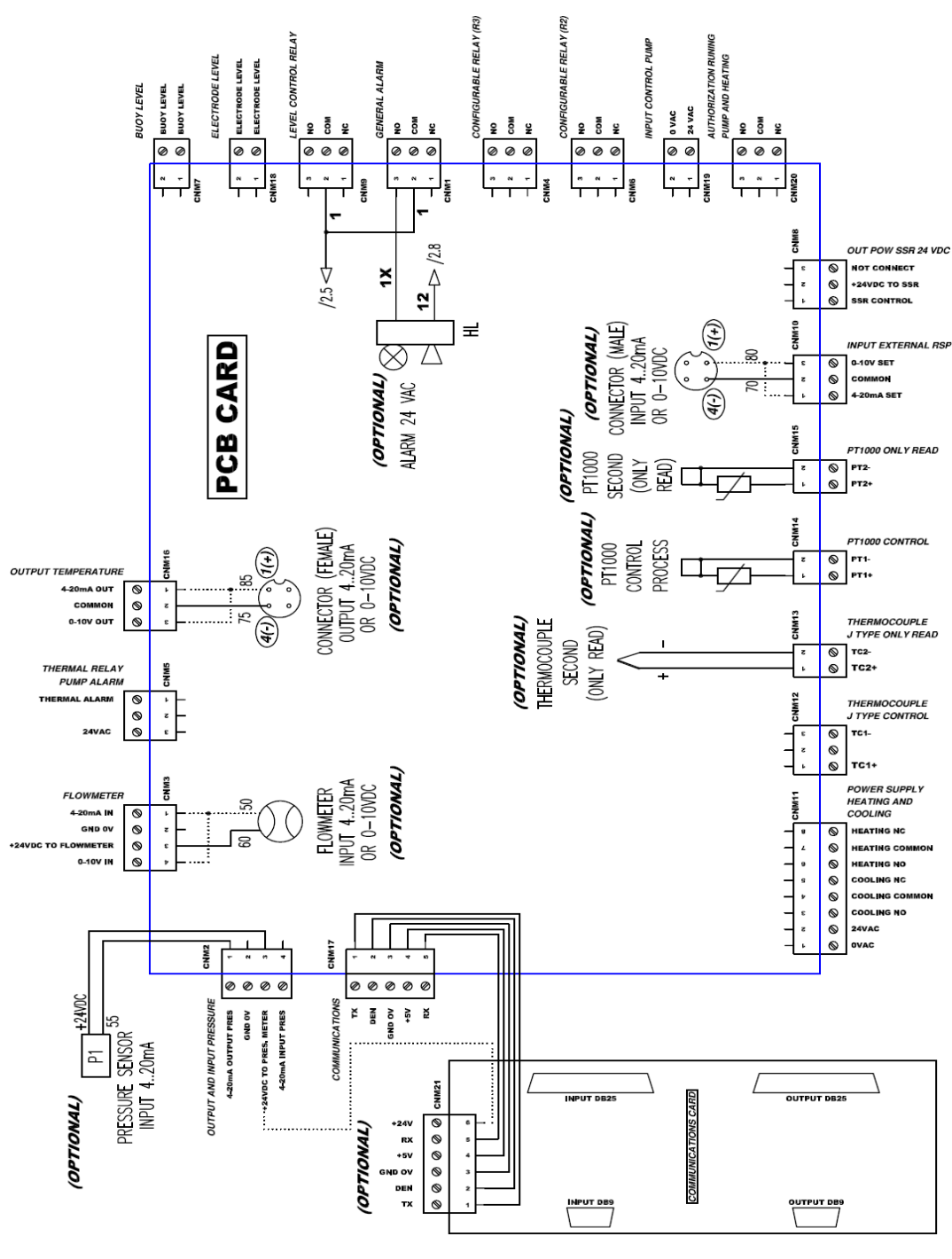

13 Maintenance

Inspection and maintenance have to be done by instructed staff (competent).

The following maintenance intervals may be required subject to use and environment:

Water filter	clean / replace	every month
Pump motor	blow out the fan	every 6 months
Hoses and pipes	check tightness	every 6 months
Pump	check tightness	every 6 months
Bolts and seals	check tightness	every 12 months
Heat transfer oil (only valid for oil units)	change	every 4'000 working hours

For extreme service, the intervals must be shortened accordingly. For temperature control units running with oil, the oil should be changed yearly, depending on the temperature. Comply with the directives and recommendations of the oil manufacturer!

13.1 Inspection

Before starting the unit has to be checked the general condition of the temperature control unit, the electrical connection and the tightness of the connections and hoses (including the consumer).

13.2 Cleaning

The temperature control unit has to be checked and cleaned periodically. Before maintenance the unit has to be disconnected from the power supply.

13.3 Repair

Established defects must be repaired. To guarantee safety the unit must be repaired with original MOULDPRO spare parts only.

WARNING	
	<p>The temperature control unit must be current less before opening! Press the main switch on the temperature control unit and pull out the mains plug! There is a danger of electric shock! Caution – risk of injury from leaking hot water or oil!</p>

CAUTION	
	<p>Waste oil has to be disposed as prescribed by law. Never let waste oil come into the sewage system or soil.</p>

14 Out-of-service / transport

Cool the temperature control unit down, mould drainage, turn it off, press the main switch and disconnect the power supply. Disconnect all hoses from the temperature control unit.

The temperature control unit is to be emptied before shipping. The danger of freezing (bursting of pipes or other components) at low temperatures can be reduced. The unit must be transported and/or stored in the operating position.

CAUTION	
	<p>Drain the unit to avoid freezing damages! Avoid compressed air, blowing out with compressed air can damage the unit! Never transport the unit lying – Lying transport will destroy the unit!</p>

15 Disposal

The temperature control unit must be drained completely and disposed of in accordance with local regulations.

The temperature control unit can also be returned to MOULDPRO for disposal.

16 Water quality

Depending on the unit to be cooled or heat-balanced, certain requirements have to be met by the cooling water regarding its quality. In order to protect all parts of the unit against corrosion, Mouldpro recommends as a matter of principle to treat the water with a suitable cleaning agent (anticorrosive as well as non-ferrous metal protector and hardness stabilizer). In addition, depending on the materials installed, the temperatures and the type of process, the following water quality data have to be met.

As a rule the following data apply:

HYDROLOGICAL DATA	MAX	UNIT
PH-value	7,5 – 8,5	-
Conductivity	< 150	mS/m
Total hardness	< 15	°dH
Carbonate hardness	< 4	°dH
Carbonate hardness in case of stabilization of hardness	< 20	°dH
Chlorid Cl	<100	mg/l
Sulphate-So4	< 150	mg/l
Ammonium NH4	< 1	mg/l
Iron Fe	< 0,2	mg/l
Manganese	< 0,1	mg/l
free from solids		

Furthermore the following applies:

- Systems with stainless steel

Chlorid Cl	Temp. < 50 °C	max. 100	mg/l
Chlorid Cl	Temp. 50 up to 90 °C	max. 50	mg/l
Chlorid Cl	Temp. > 90 °C	max. 30	mg/l

- Systems with aluminium

PH-value	min. 7,0	max. 8,0
----------	----------	----------

- Temperatures below 5°C
 - When employing chillers at temperatures below + 5°C, an anti-freeze medium with corrosion inhibitor must be added.
- Temperatures over 120°C
 - At water temperatures over 120°C glycol may not be used.

If the recommended water qualities are not met, the components of the unit will be damaged due to corrosion. Mouldpro will not accept any liability for any such damages

18 Water Circuit Diagram

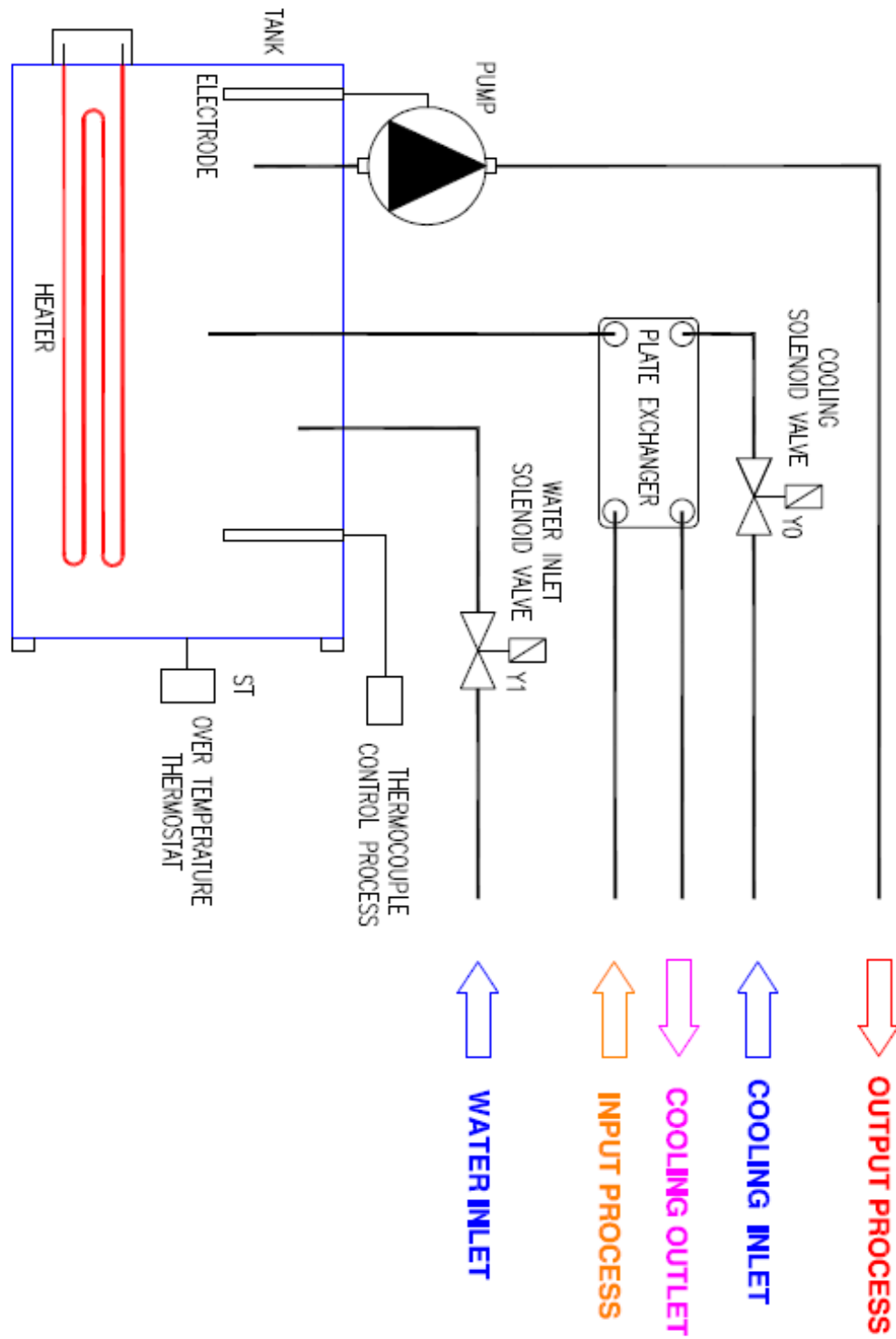

19 Control Circuit diagram

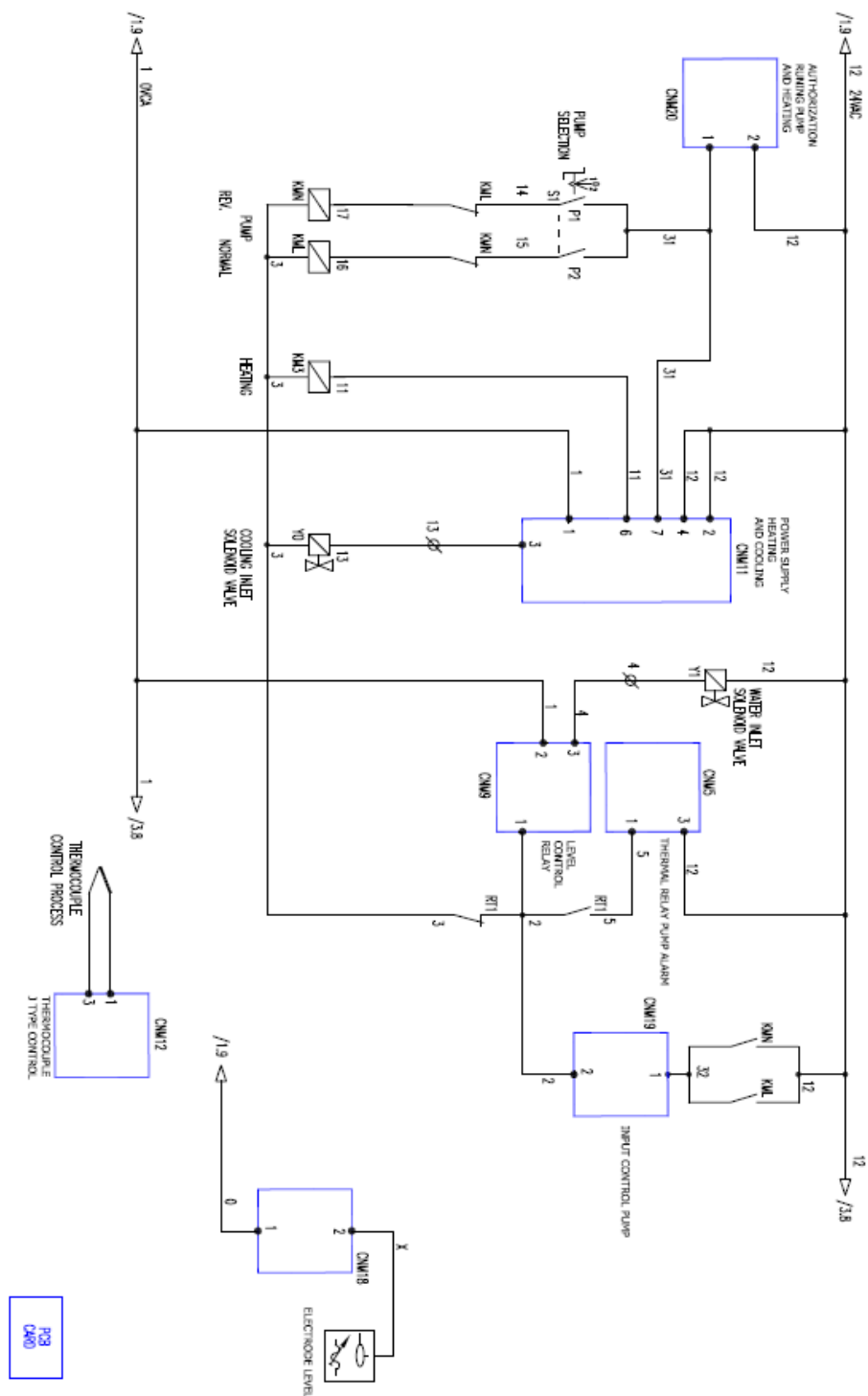

20 Components and spare part list

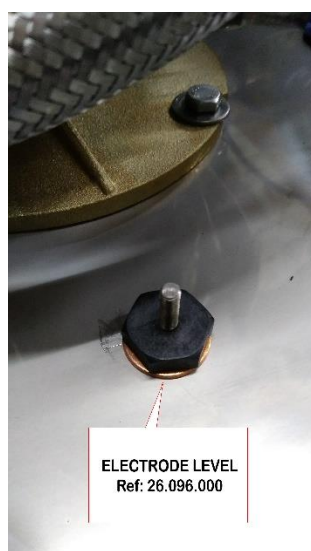
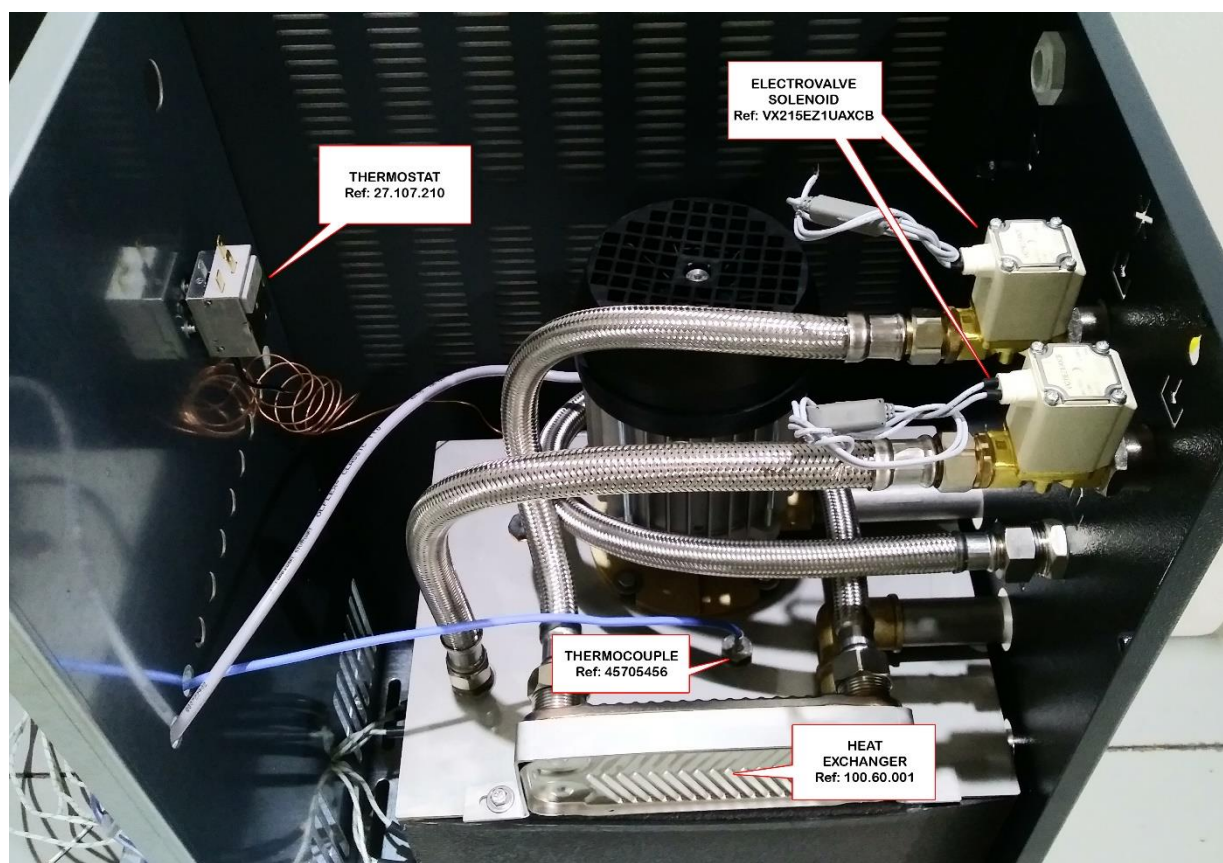

[41]

12-06-2019

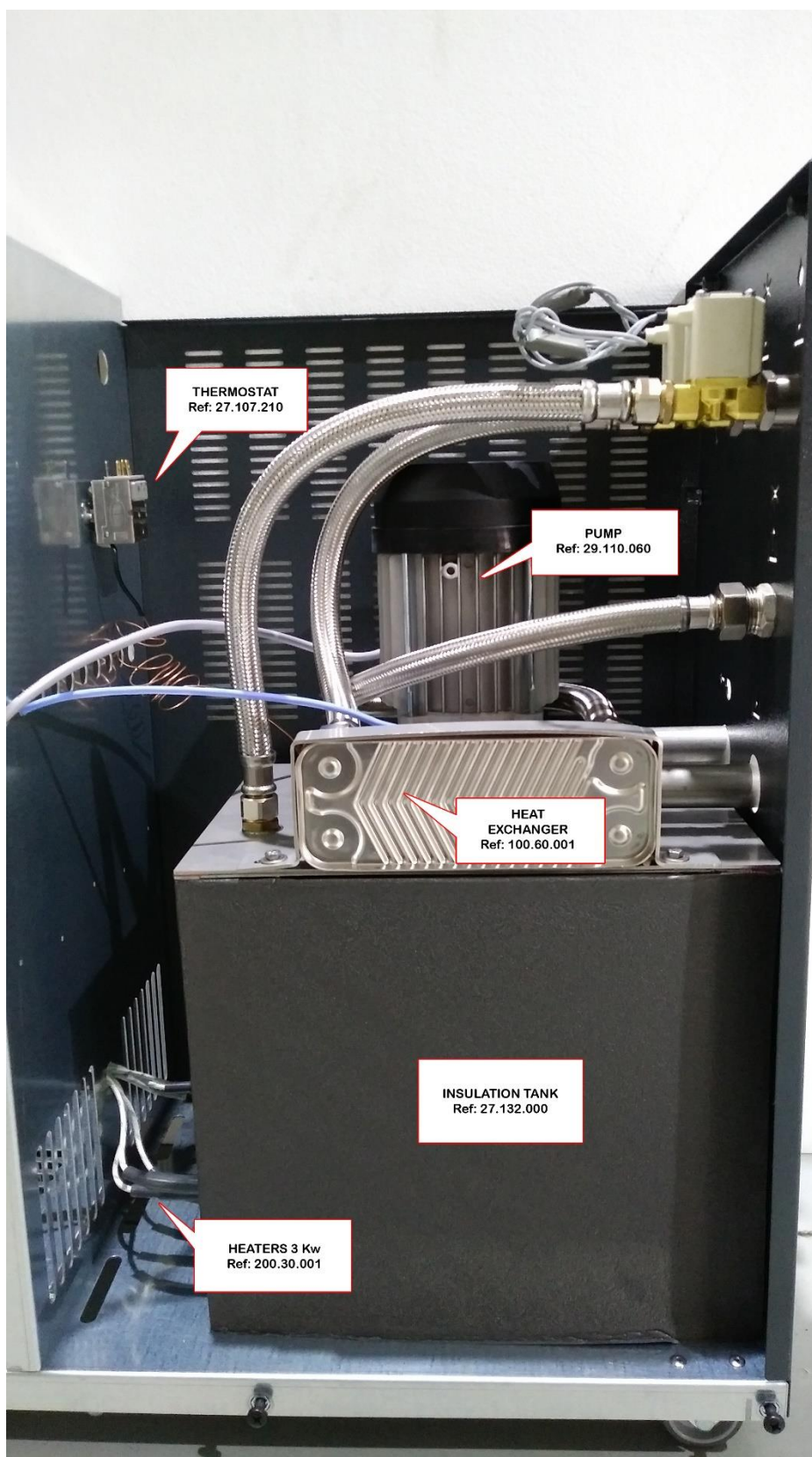

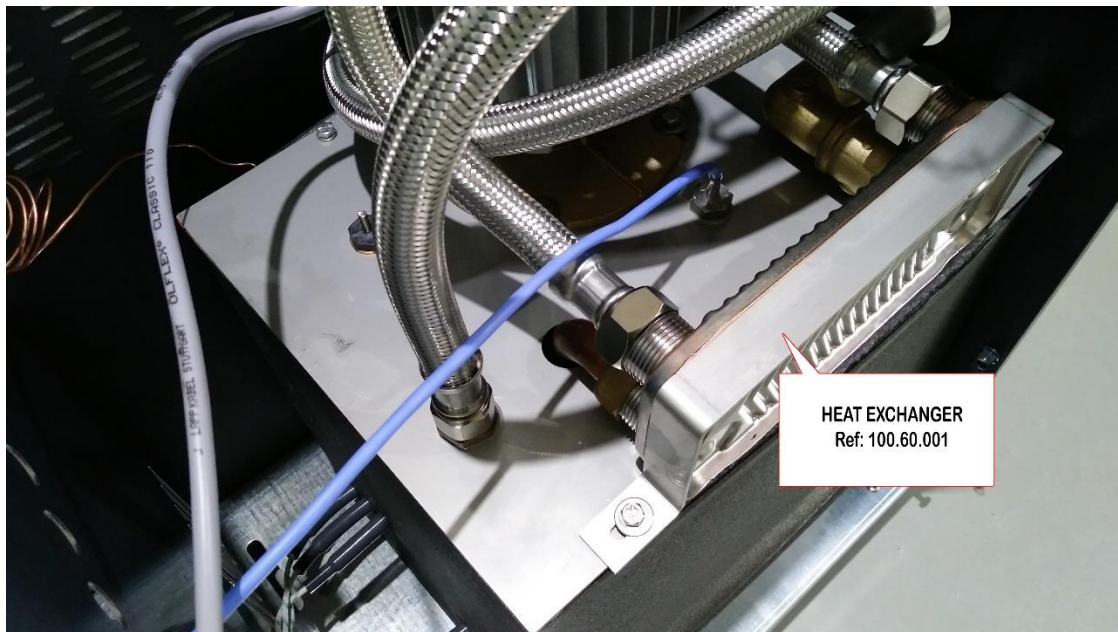

Change log

Date of change	Change	Version
26-04-2019	layout	002
12-06-2019	Spare partslist	003